

1

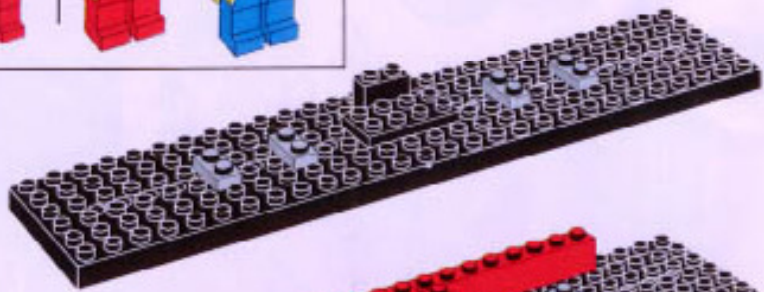

2

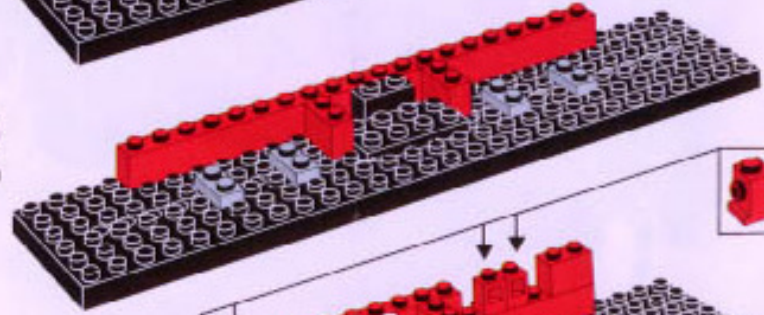

3

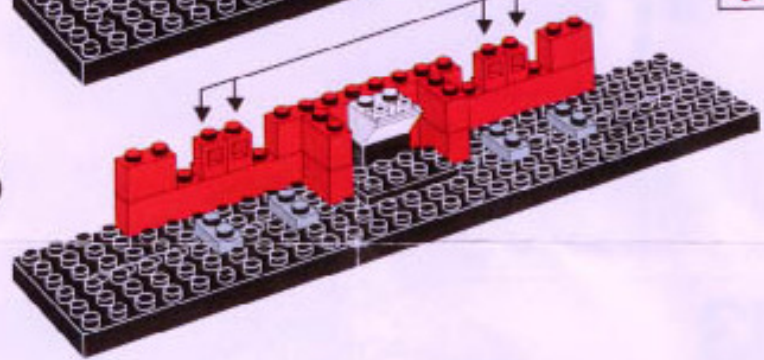

1



2

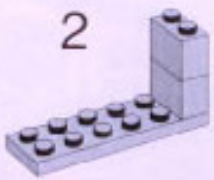

3

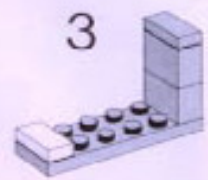

X2

4

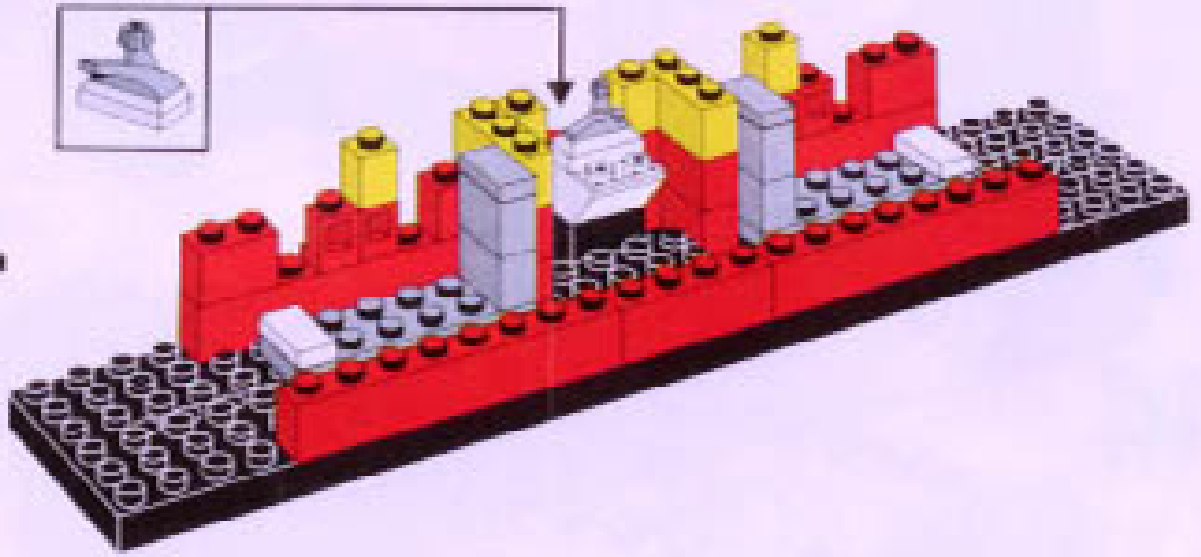
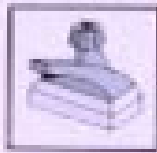

1

2

3

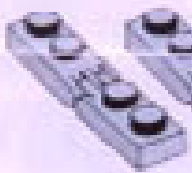

x2

5

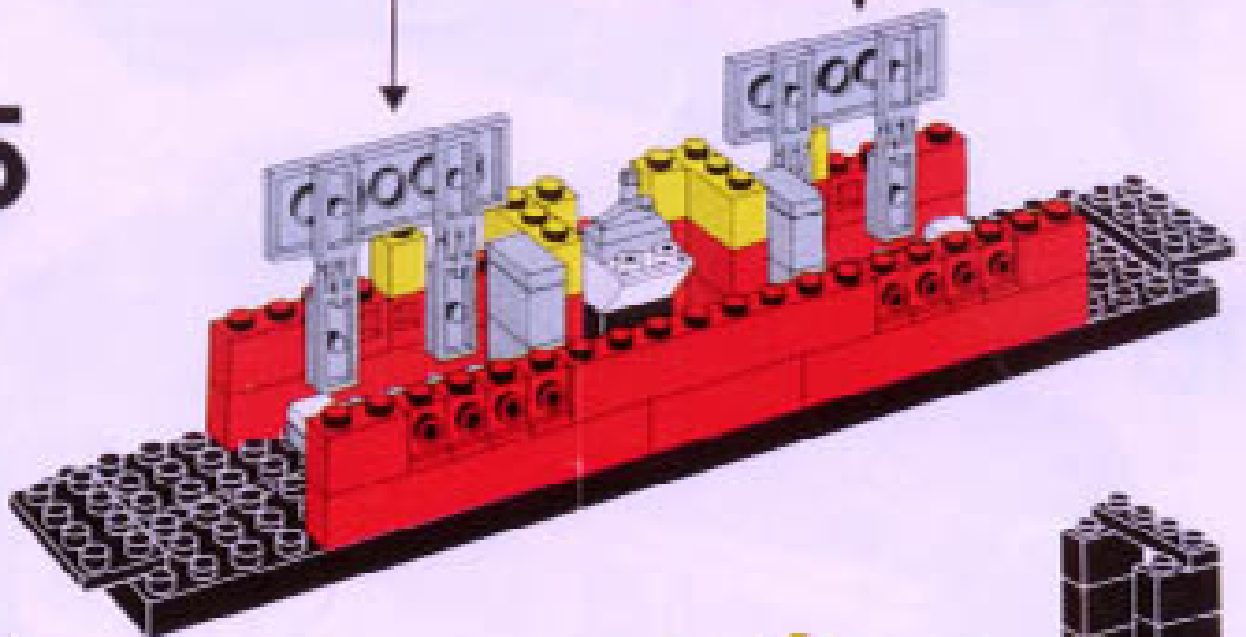

6

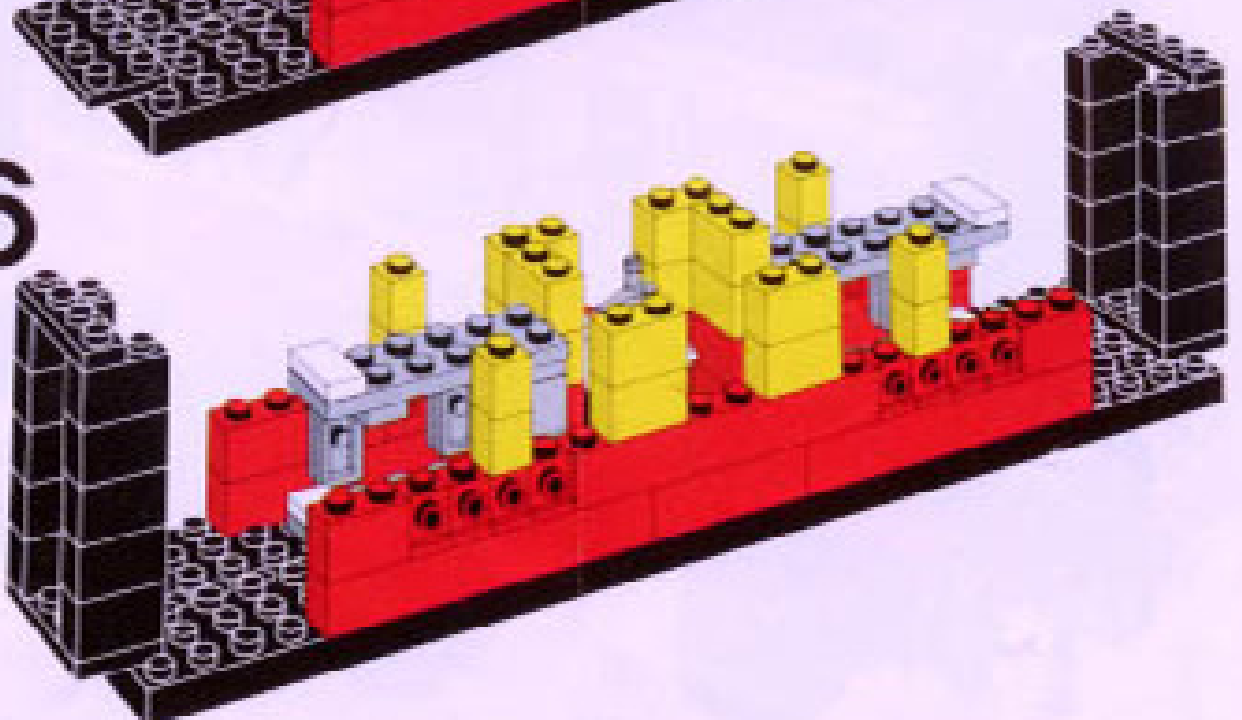

7815



120254

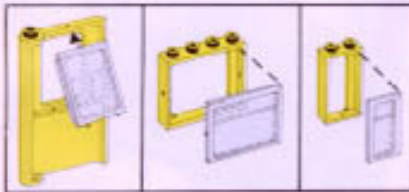

7

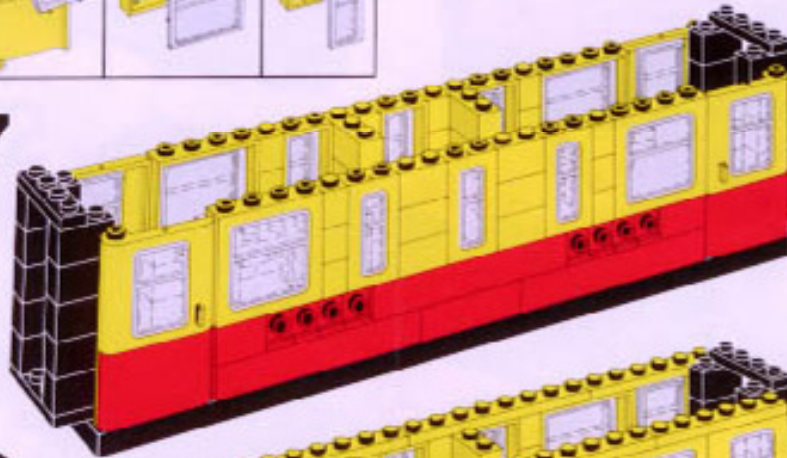

8

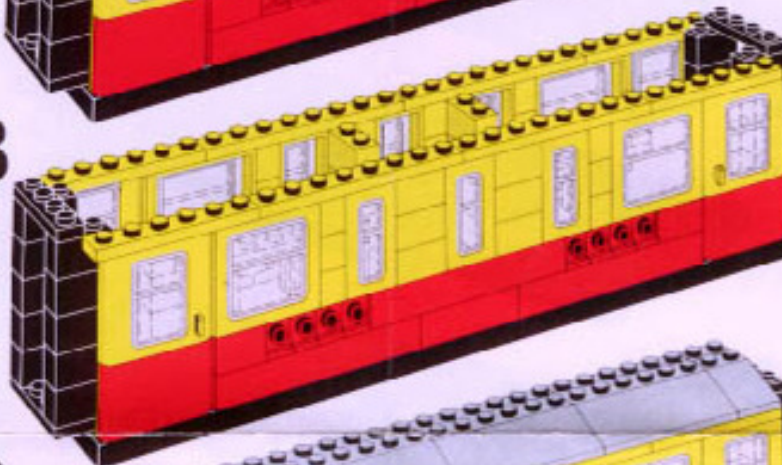

9

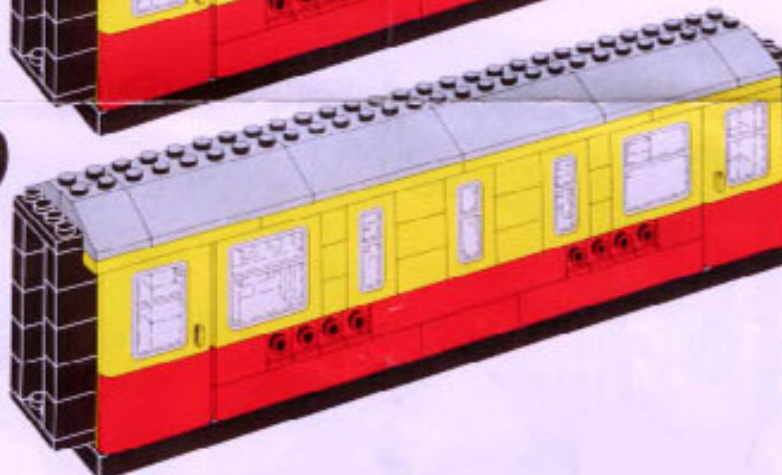

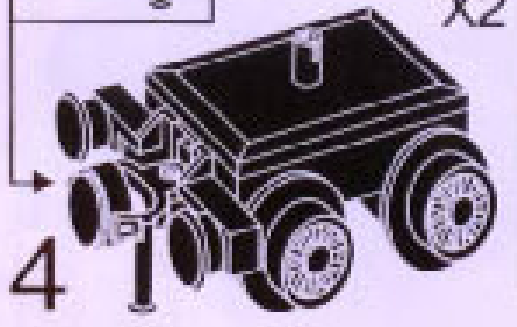
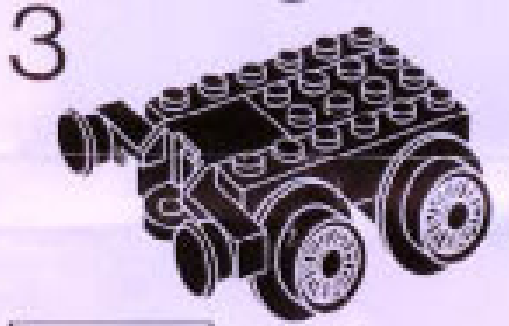
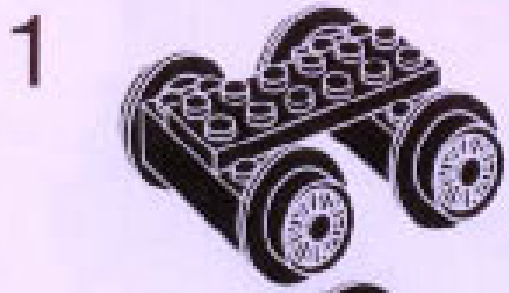

10

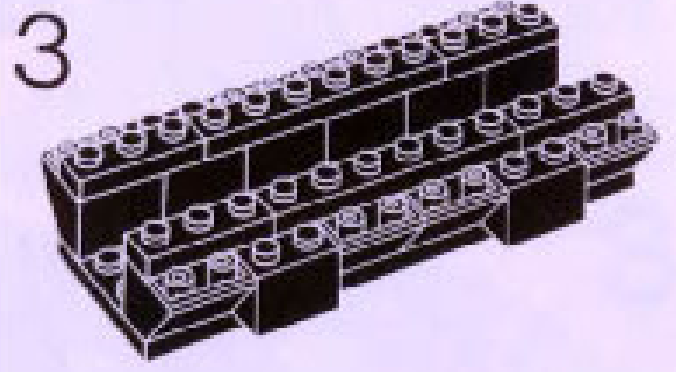
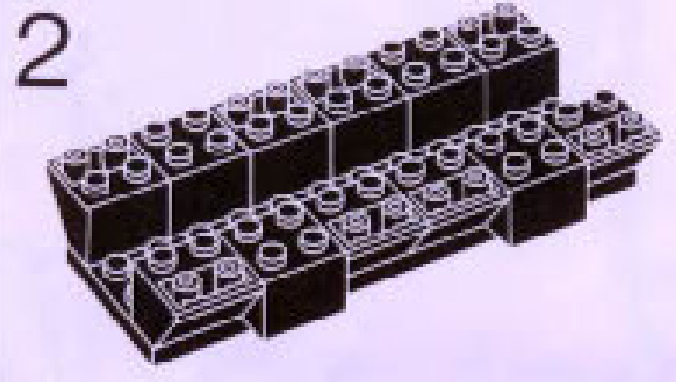
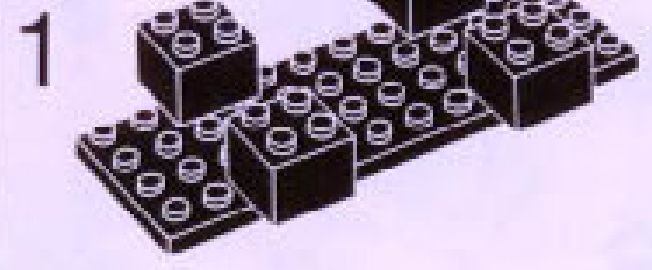
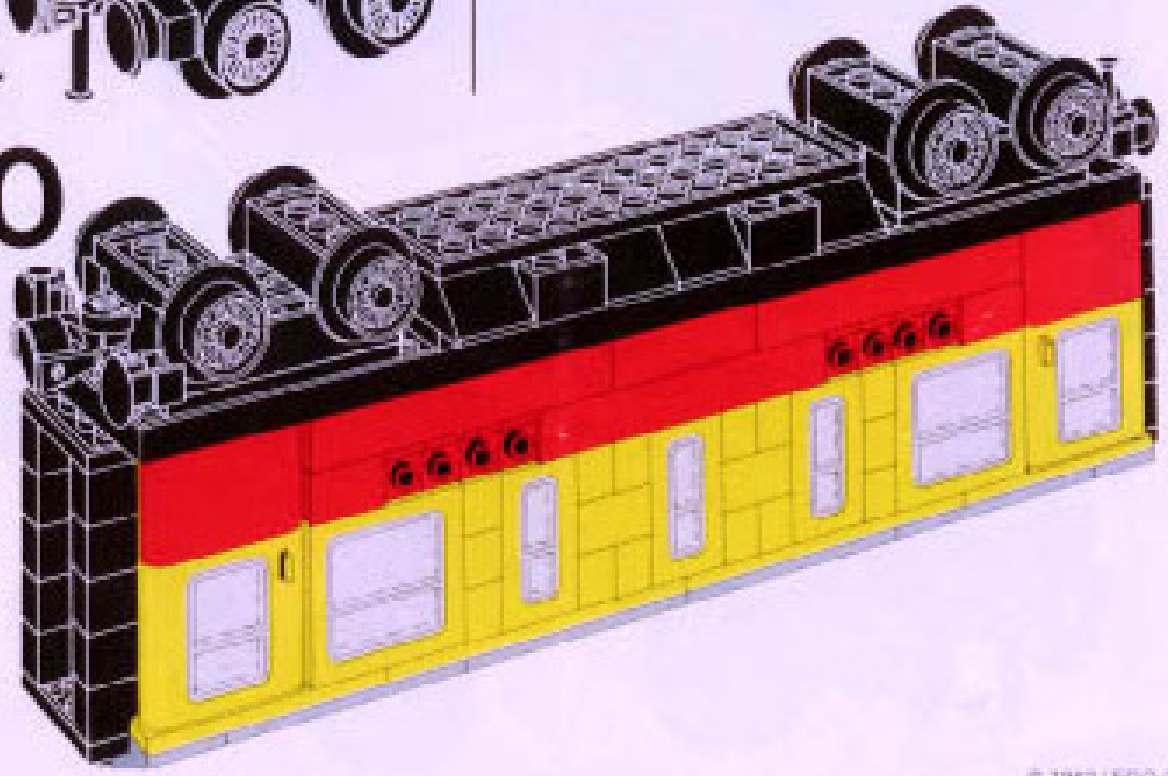

11

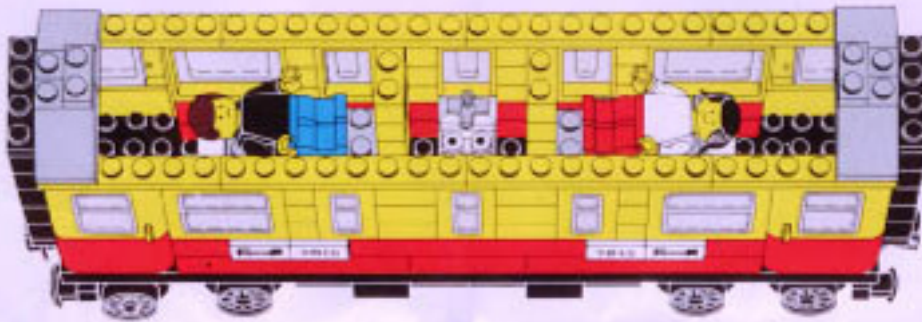
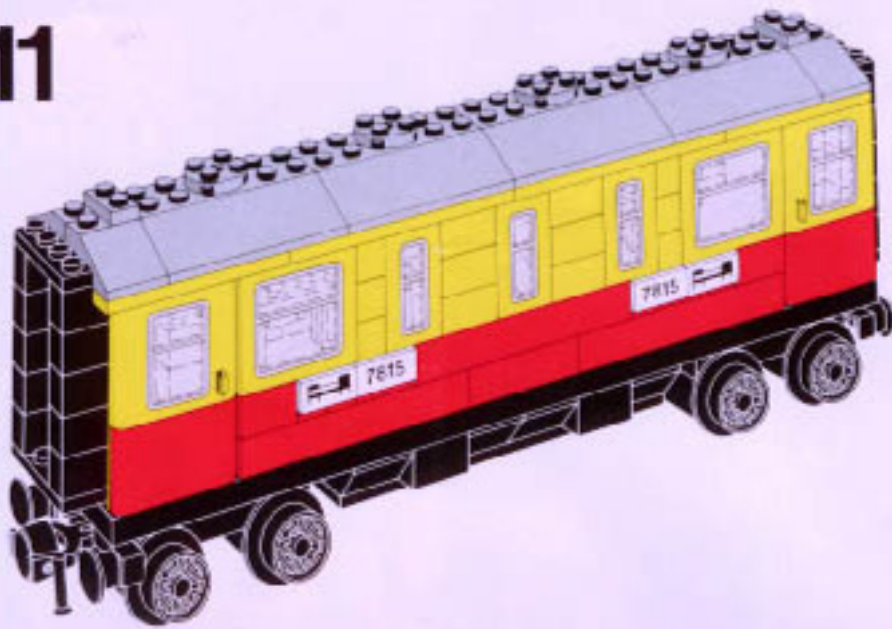

1

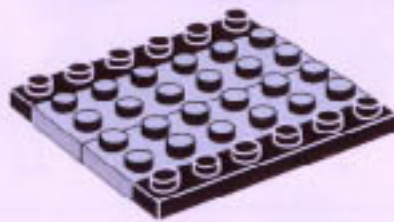

2

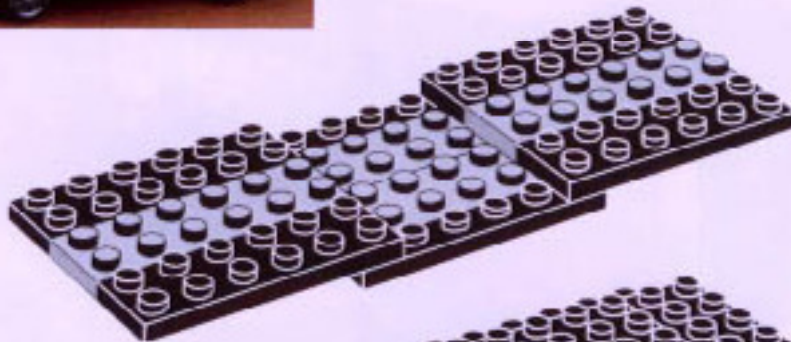

3

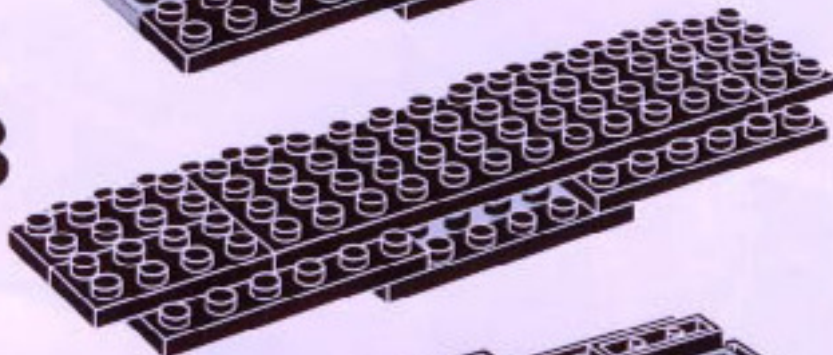

4

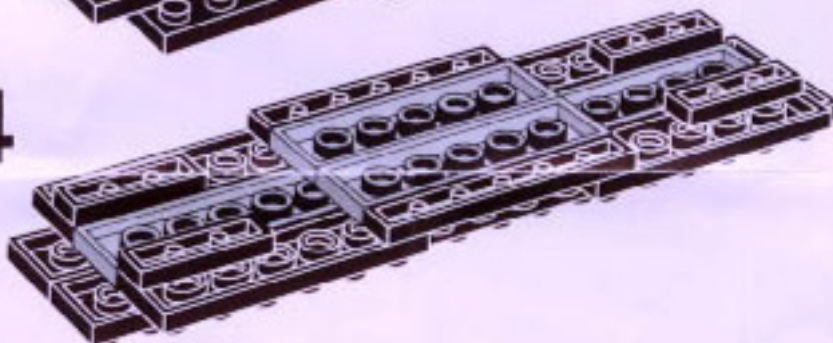

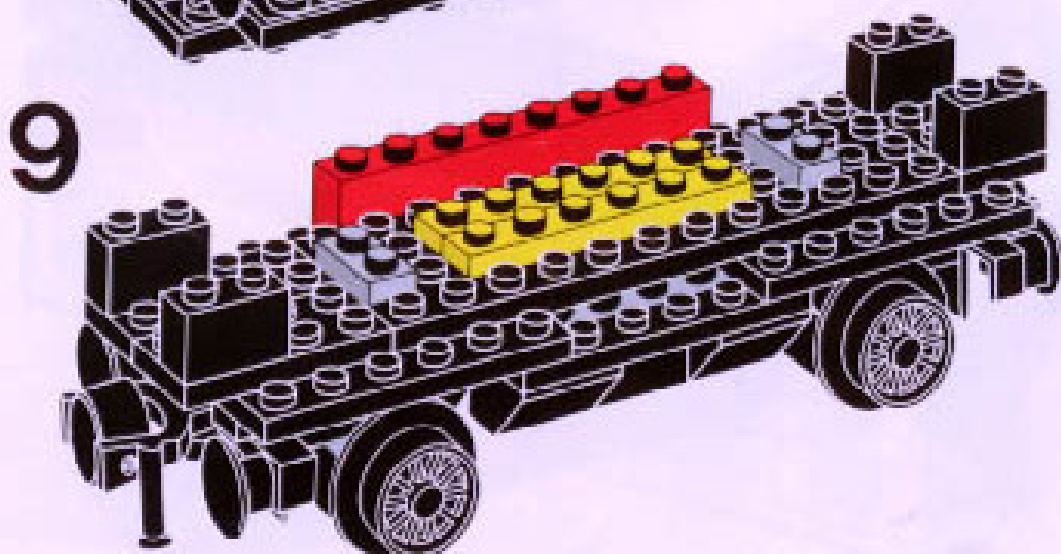
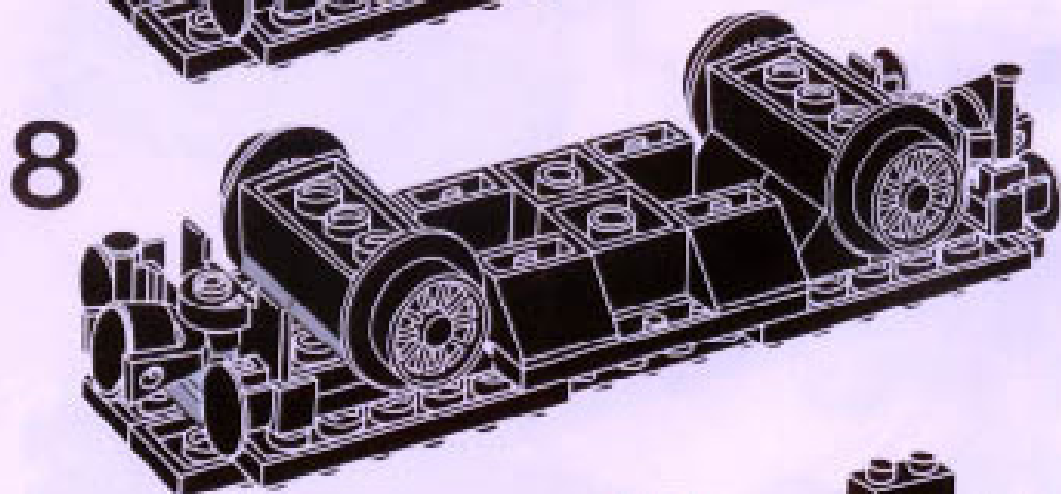
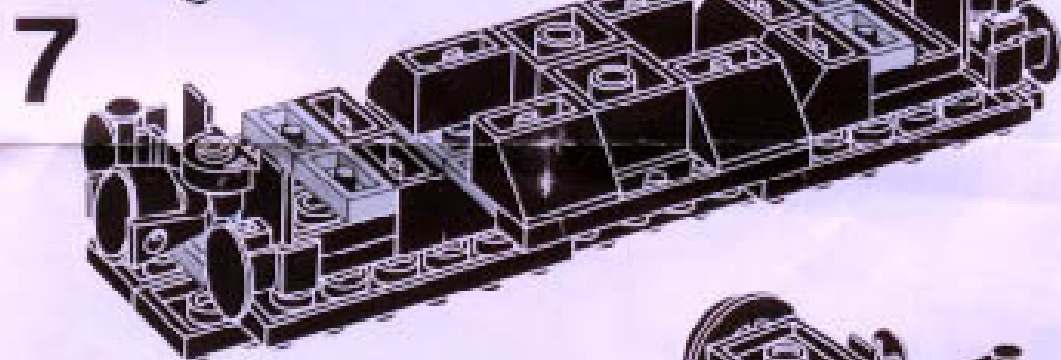
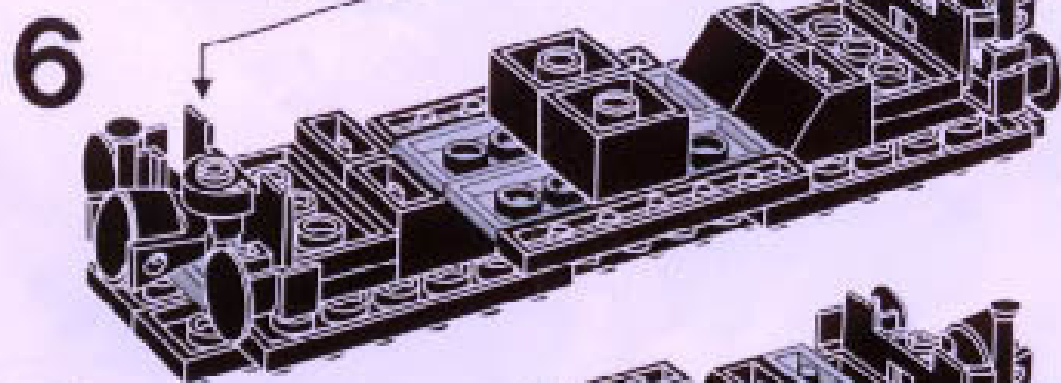
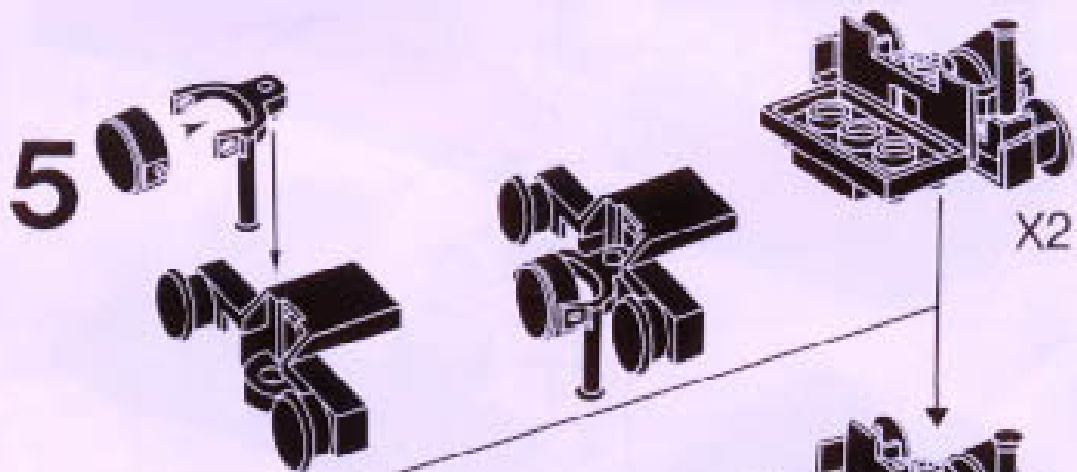

10

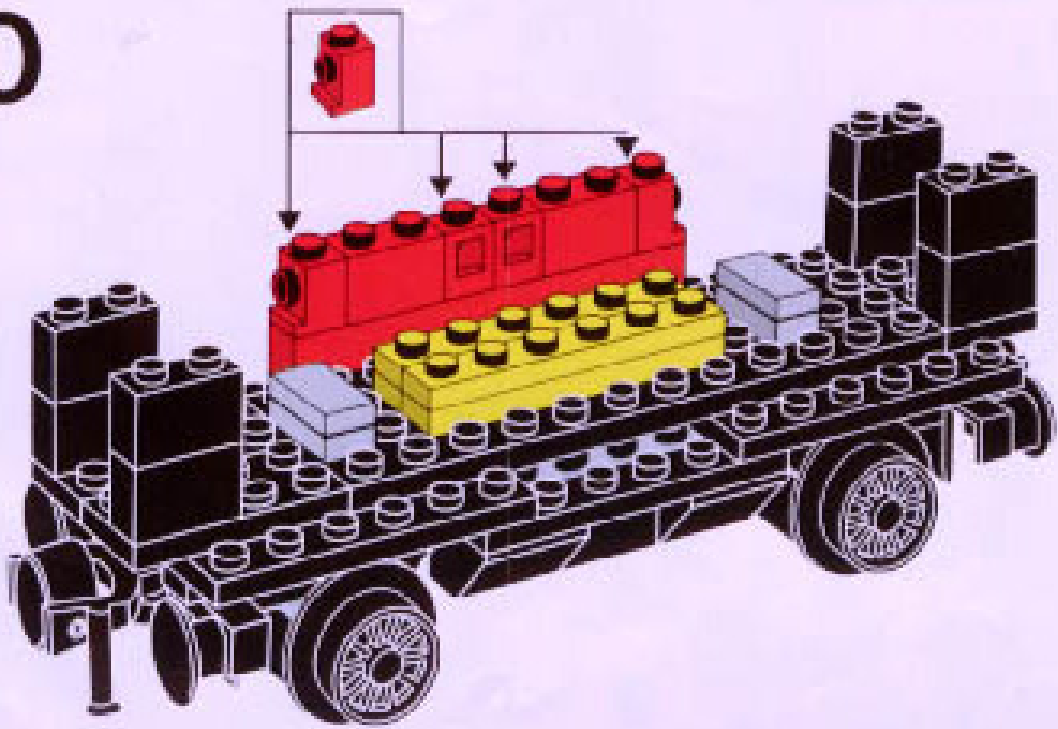

11

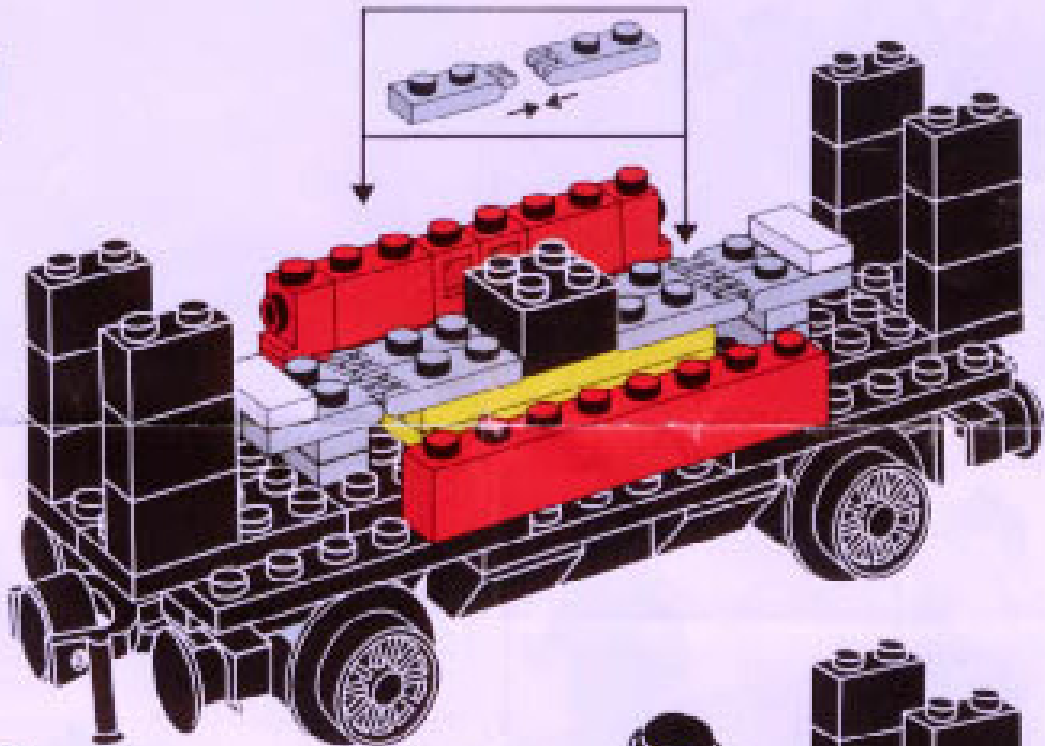

12

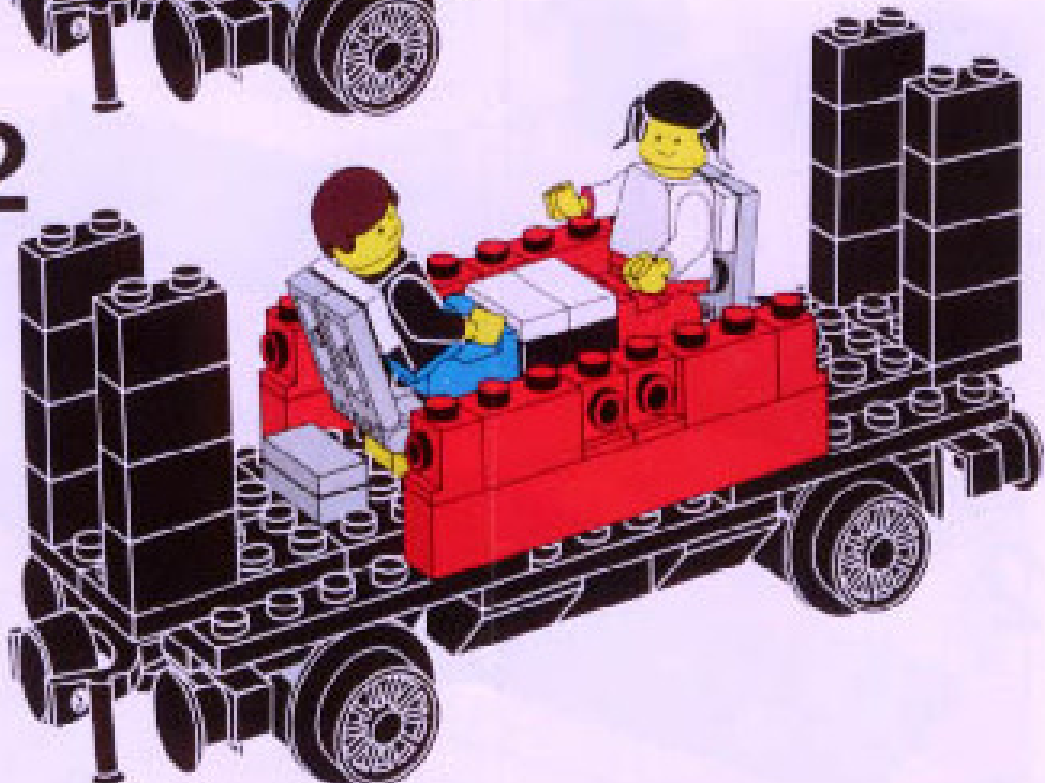

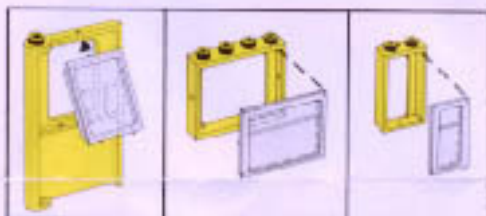

13

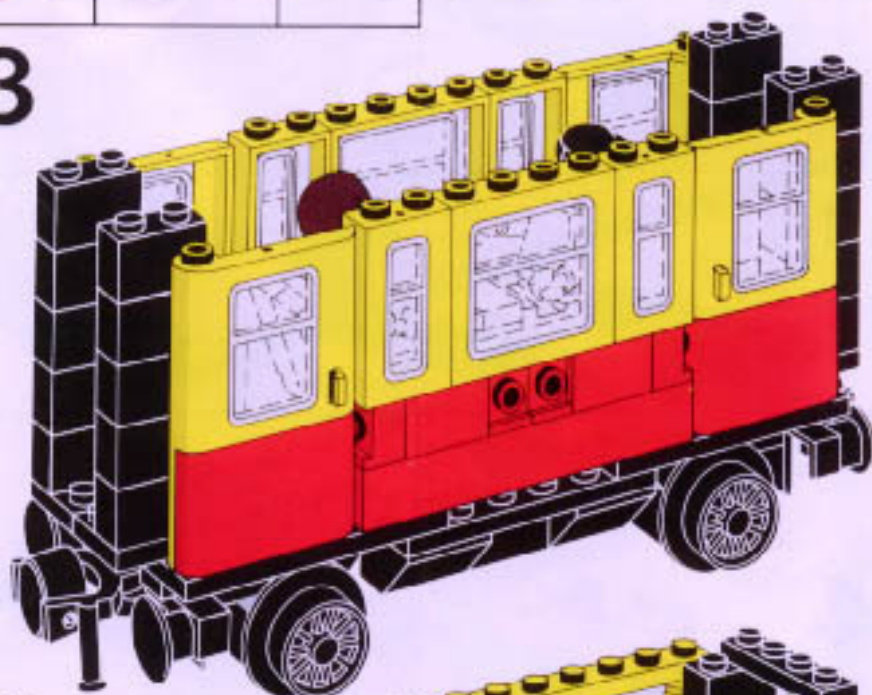

14

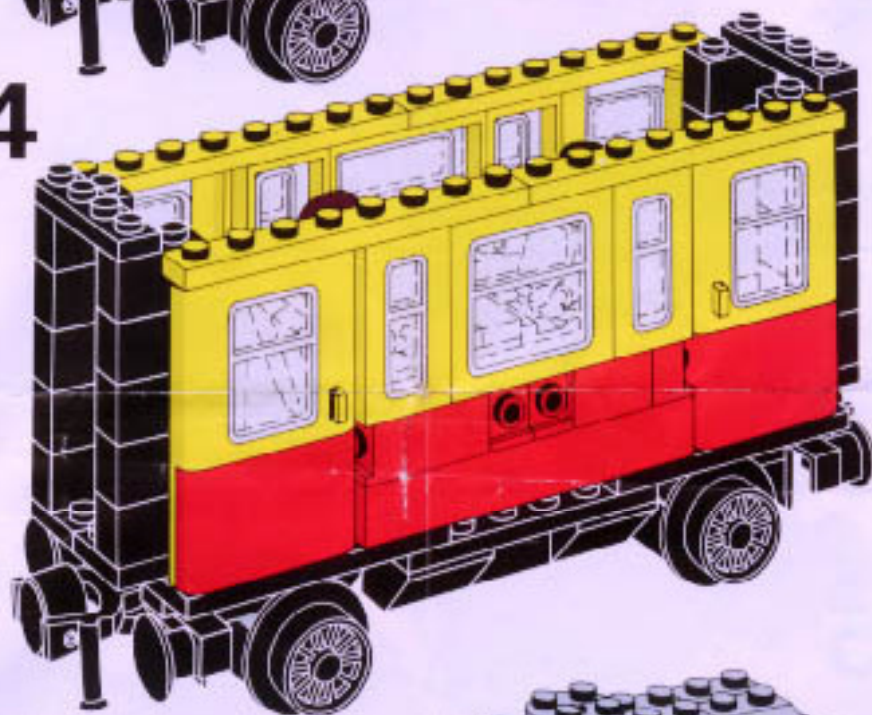

15

